

















# Instructions VFG 2, VFG 21, VFG 27, VFG 25, VFGS 2 DN 15 - 125

						
Instructions 	Instructions 	Instructions 	Instructions 	Instructions 	Instructions 	Instructions 
AFD / VFG.. AFP / VFG..	AFA / VFG.. AFPA / VFG..	SAF / VFG	AMV(E) 4.. / VFG..	AMV(E) 6.. / VFG..	AFT... / VFG.. STFW / VFG	STFL / VFG..
						
AFD / AFP	AFA / AFPA	SAF	AMV (E) 4..	AMV (E) 6..	AFT... STFW	STFL

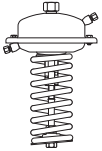
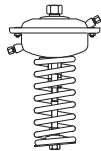

# Instructions

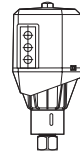
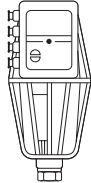
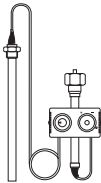
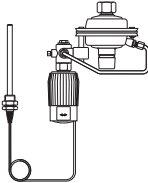
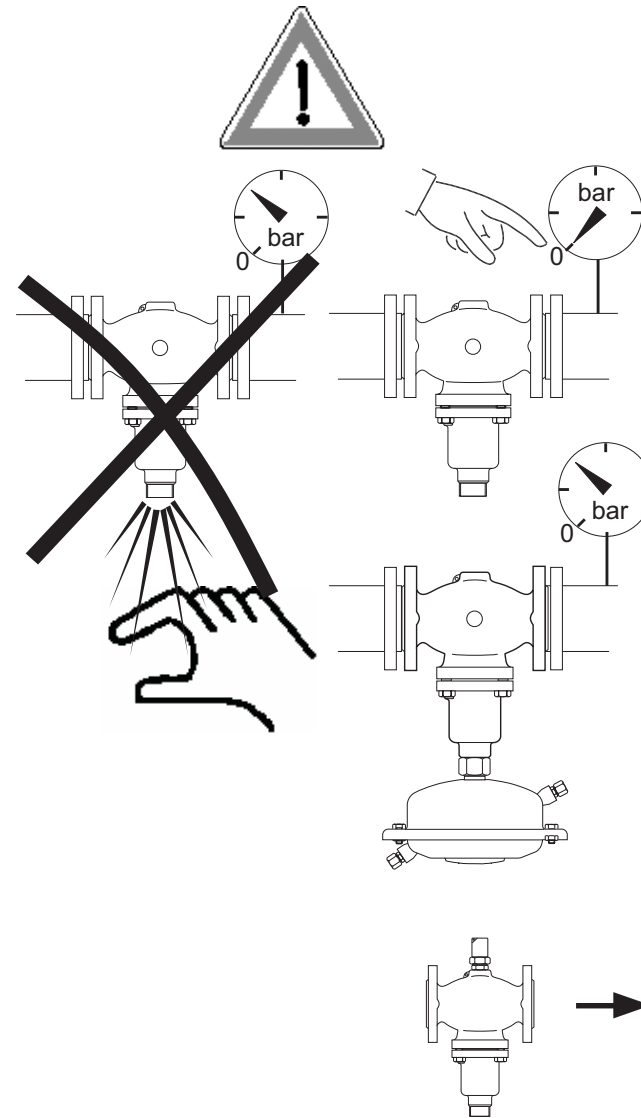
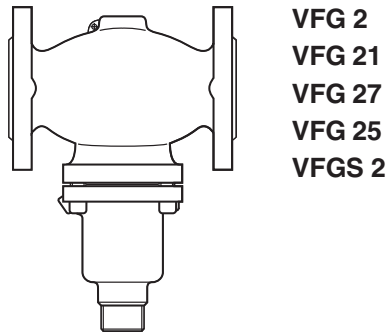
## VFQ 2, VFQ 21 DN 15 - 125

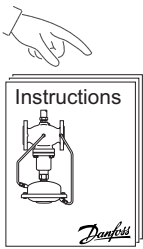

AFQ / VFQ..

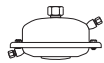

AFQ

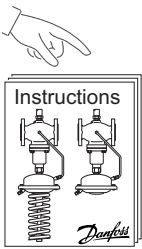

AFPB (-F) / VFQ..

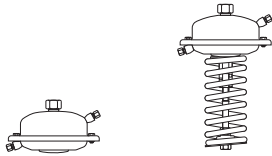

AFPB-F

AFP

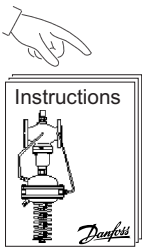

AFPQ (4) / VFQ..

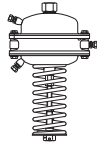

AFPQ,  
AFPQ.4

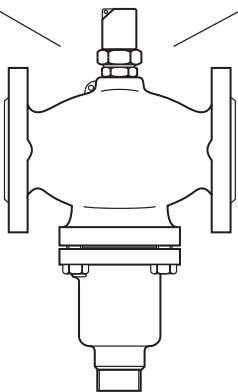

VFQ 2  
VFQ 21

